

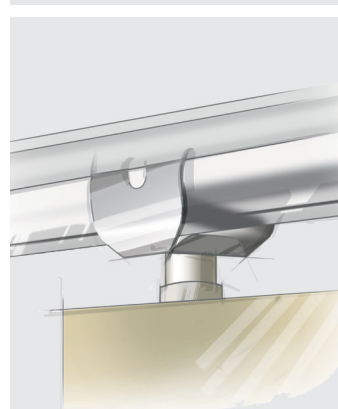

**Heradesign®**

Product data

HERADESIGN® superfine A2

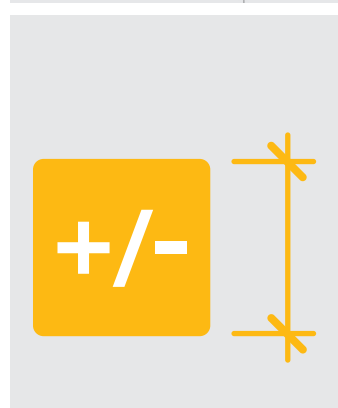
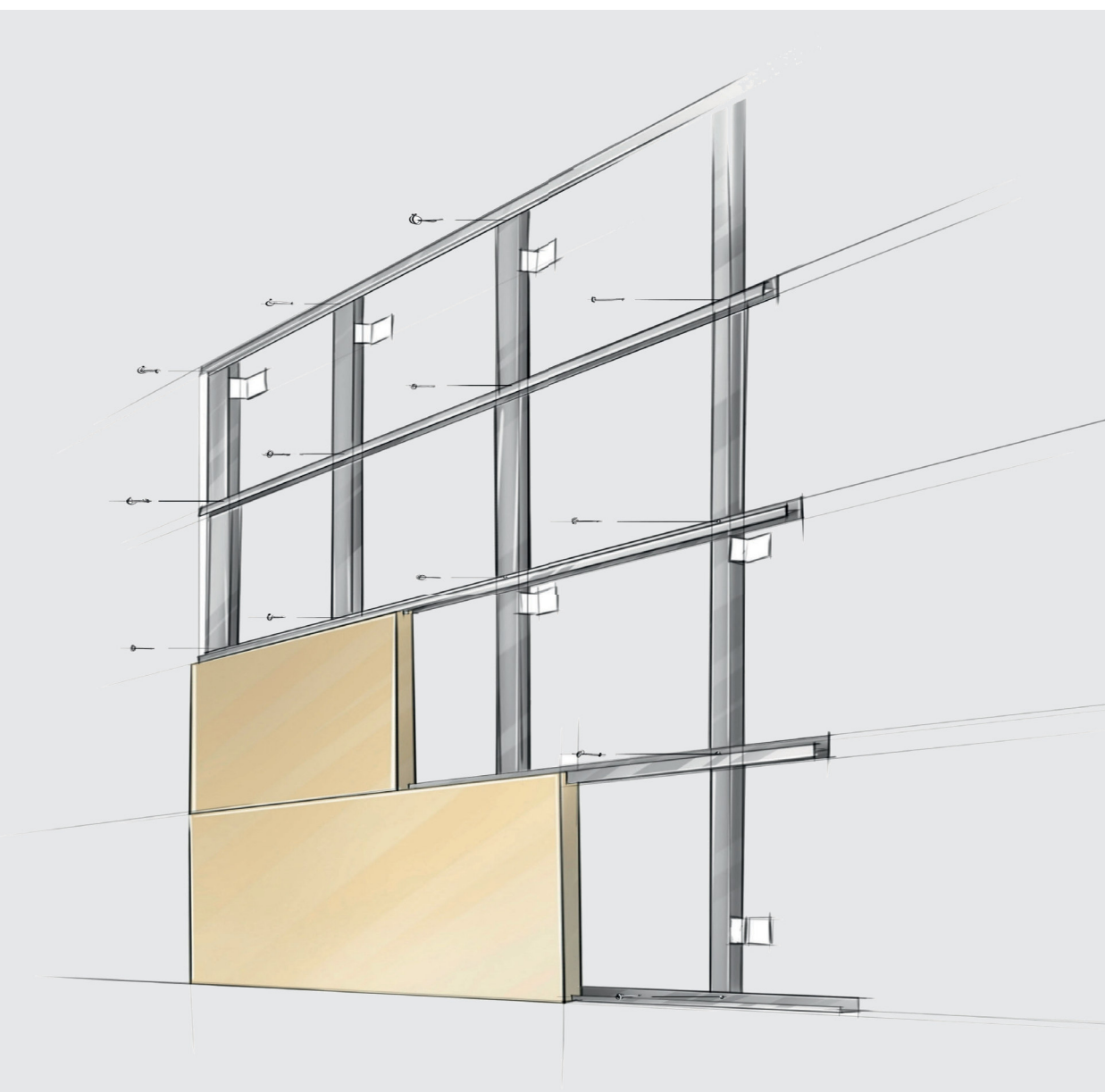

# Product data

## HERADESIGN® superfine A2

1 Single layer layer, non-flammable, magnesite bonded wood wool acoustic panel (fibre width 1 mm). With high quality surface structure, building biology recommended.

### Colour variants

The natural characteristic structure of the wood wool is ideally suitable as a surface for creative colour schemes. An almost unlimited range of colours is available - almost any colour from popular colour systems such as RAL, NCS, BS or StoColor may be selected!

Nominal dimensions [mm]	600 x 600, 625 x 625, 1200 x 600, 1250 x 625	
Thickness [mm]	15	25
Weight [kg/m <sup>2</sup> ]	12.0	18.0
Sound absorption value $\alpha_w$ up to 0.95		
Reaction to fire as per EN 13501-1: <b>A2-s1, d0</b>		
Designation code: WW-EN 13168-L4-W2-T2-S2-P2-CI3		
General Building Authority Approval: Z-23.15-1562		
Declaration of performance under <a href="http://www.knaufamf-dop.com">www.knaufamf-dop.com</a>		

White similar to RAL 9010	beige Natural tone 13	Pastel colours	Solid colours	Metallic colours	Special colours
●	●	●	●	●	●

### Areas of application

As decorative and acoustically effective sub-ceiling and wall cladding for use in interior rooms and roofed outdoor areas, which are not exposed to direct environmental influences such as rain or pollutants.

### Limitations of use

- Maximum span 625 mm!
- Suitable for rooms with a constant humidity of up to 90%. For applications where there is a constant humidity in excess of 80% construction physics advice is recommended!
- Not suitable for installation with adhesives!

### Installation

Installation of HERADESIGN® acoustic panels is part of the interior fitting of the building and must only be carried out under conditions of controlled humidity and temperature. All building activities which create dust must be completed before the start of installation. Store the panels flat and protect against moisture and dirt. The packaging does not protect the products against rain! Also note the relevant application, installation and storage guidelines for HERADESIGN® acoustic panels.

### Special information

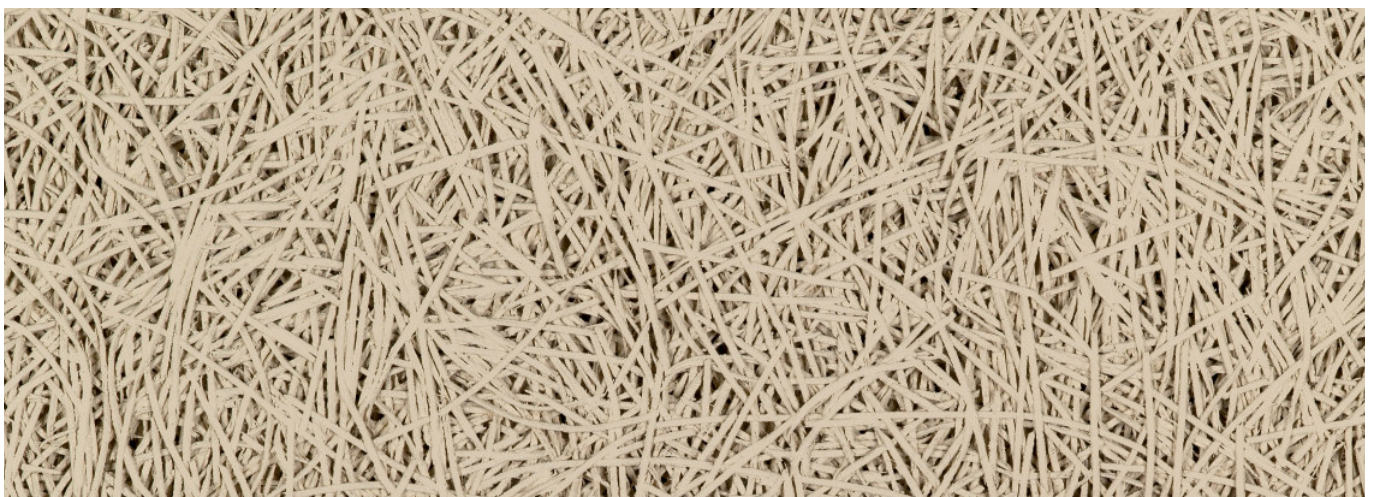

- Deviations in colour from the edge colour and colour perception are possible due to the rough surface of the fibres or the surface of the panel.
- Manufacturing tolerances in nominal dimensions: L4, W2, T2:  $\pm 1$  mm, for lengths  $> 1250$  mm L4:  $\pm 2$  mm
- A foil (thickness  $< 30 \mu\text{m}$ ) is recommended for trickle protection for mineral wool linings.
- Max. changes in dimension in standard climate 23° C/50 % rel. humidity:  $\pm 1 \%$





This product information corresponds to the present state of development of our products and become invalid on the publication of a new version. Always make sure that you use the latest version of this information. The suitability of the product is not binding for special individual cases. Warranties and liability for deliveries are governed by our General Terms of Business. All data are included without warranty. Version 12/2016 - JB

# Overview of test reports

## Ball impact resistant ceiling panelling according to DIN 18 032 / part 3 or EN 13964 Annex D

Construction	Product	Substructure		Center distance support profile	Installation	Fastening	Test report No.
	<b>HERADESIGN® superfine A2</b> Thickness : 25 mm Format: 1200 x 600	CD sections 60x27x0,6 mm	Double layer	≤ 600 mm	Transverse to substructure	HERADESIGN® screw 9 pcs/panel	903 1172 000/3/Ma/H MPA Stuttgart
	<b>HERADESIGN® superfine A2</b> Thickness : 25 mm Format: 1200 x 600	Wooden battens 60x30 mm	Double layer	≤ 600 mm	Transverse to substructure	HERADESIGN® screw 9 pcs/panel	902 9567 000/12/Sc/Whr MPA Stuttgart

## Ball impact resistant wall panelling according to DIN 18 032 / part 3

Construction	Product	Substructure		Center distance support profile	Installation	Fastening	Test report No.
	<b>HERADESIGN® superfine A2</b> Thickness : 25 mm Format: 1200 x 600	Wooden battens 60x30 mm	Double layer	≤ 300 mm	Transverse to substructure	HERADESIGN® screw 9 pcs/panel	902 7763 000/13/Sc/Whr MPA Stuttgart
	<b>HERADESIGN® superfine A2</b> Thickness : 25 mm Format: 1200 x 600	CD sections 60x27x0,6 mm	Single layer	≤ 300 mm	Transverse to substructure	HERADESIGN® screw 9 pcs/panel	902 7254 000/02/Sc/Whr MPA Stuttgart
	<b>HERADESIGN® superfine A2</b> Thickness : 35 mm Format: 1200 x 600	CD sections 60x27x0,6 mm	Double layer	≤ 300 mm	Transverse to substructure	HERADESIGN® screw 9 pcs/panel	903 0762 000/1/Ma/H MPA Stuttgart

## Sound absorption values

Test specimen				Sound absorption coefficient $\alpha$																											
Panel type	Thick-ness [mm]	TKH <sup>1)</sup> [mm]	HERADESIGN® Acoustic lining		Frequencies [Hz], as												Frequencies [Hz], ap				entire range		Class								
			[mm]	Gross density [kg/m <sup>3</sup> ]	100	125	160	200	250	315	400	500	630	800	1000	1250	1600	2000	2500	3150	4000	5000		125	250	500	1000	2000	4000	NRC	$\alpha_w$
<b>without acoustic lining</b>																															
HERADESIGN® superfine A2	15	45	0	---	0,03	0,05	0,05	0,09	0,11	0,15	0,21	0,31	0,48	0,65	0,72	0,73	0,62	0,53	0,46	0,45	0,51	0,71	0,05	0,10	0,35	0,70	0,55	0,55	0,40	0,35 (MH)	D
HERADESIGN® superfine A2	25	25	0	---	0,06	0,07	0,08	0,11	0,12	0,18	0,23	0,30	0,39	0,48	0,62	0,79	0,95	0,97	0,88	0,72	0,77	0,94	0,05	0,15	0,30	0,65	0,95	0,80	0,50	0,35 (MH)	D
<b>with acoustic lining</b>																															
HERADESIGN® superfine A2	15	45	30	50	0,11	0,10	0,18	0,35	0,49	0,72	0,88	1,00	1,04	1,01	0,92	0,79	0,88	0,59	0,56	0,58	0,69	0,84	0,15	0,50	0,95	0,90	0,60	0,70	0,75	0,70 (M)	C
HERADESIGN® superfine A2	25	200	40	50	0,34	0,58	0,88	0,95	1,07	1,11	1,09	1,10	1,03	1,04	0,95	0,89	0,85	0,84	0,90	1,00	1,09	0,95	0,60	1,00	1,00	0,95	0,85	1,00	1,00	0,95 (L)	A
HERADESIGN® superfine A2	25	200	50	90	0,36	0,53	0,84	0,95	1,02	1,06	1,04	1,00	1,02	0,98	1,00	0,90	0,91	0,90	0,94	1,01	1,11	1,10	0,60	1,00	1,00	0,95	0,90	1,00	1,00	0,95 (L)	A
HERADESIGN® superfine A2	25	200	100	90	0,44	0,78	0,84	0,92	0,96	1,09	1,10	1,04	1,07	0,99	0,98	0,93	0,91	0,91	0,95	0,99	1,10	1,06	0,70	1,00	1,00	0,95	0,90	1,00	0,95	0,95 (L)	A

<sup>1)</sup> TKH: Total construction height: Lower edge of ceiling to lower edge of HERADESIGN® acoustic panel  
NRC value: Average  $\alpha_s$  over the frequencies (250 + 500 + 1000 + 2000):4, rounded to the next increment 0.05

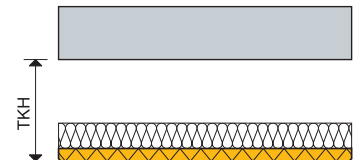

## Fire resistance duration

Construction	Product	Substructure	Mineral wool lining	Classification	Evidence	AbP No./Institut
	<b>HERADESIGN® superfine A2</b> Thickness: 25 mm	CD sectionse 60x27x0,6 mm	Auflage 2 x 50 mm Gross density: 90 kg/m <sup>3</sup>	<b>EI 30</b> (a←b)	No. 3183/183/13 MPA Braunschweig D	P-MPA-E-16-005 MPA-NRW Erwitte



## Service, Support, Logistics – Centre of expertise in Europe and on-site sales networks worldwide



**Knauf AMF GmbH & Co. KG**  
Elsenthal 15, 94481 Grafenau  
Germany

Tel.: +49 8552 422-0

Fax: +49 8552 422-32

[info@knaufamf.de](mailto:info@knaufamf.de)

[www.amfceilings.com](http://www.amfceilings.com)

The acoustic ceiling specialist Knauf AMF, with its global sales and service network, offers on-site, solution orientated and timely advice for architects, specialist contractors, distributors and developers.

**With us, you are always a ceiling solution ahead!**

No responsibility or liability is accepted for the accuracy of the information provided.  
Subject to change without prior notice.

12/2016

**Knauf AMF Deckensysteme GmbH**  
9702 Ferndorf 29  
Austria  
Tel.: +43 4245 2001-0  
[office@heradesign.com](mailto:office@heradesign.com)  
[www.heradesign.com](http://www.heradesign.com)

**Knauf AMF GmbH & Co. KG**  
Metallstraße 1, 41751 Viersen  
Germany  
Tel.: +49 2162 957-0  
[info-de@knaufamf.eu](mailto:info-de@knaufamf.eu)

**Knauf AMF Plafonds et Systèmes**  
9, rue des Livraindières, 28100 Dreux  
France  
Tel.: +33 237 3850-50  
[info@knaufamf.fr](mailto:info@knaufamf.fr)

**Knauf AMF Ceilings Ltd.**  
1 Swan Road, South West Industrial Estate,  
Peterlee, Co. Durham, SR8 2HS  
Great Britain  
Tel.: +44 191 5188600  
[info@knaufamf.co.uk](mailto:info@knaufamf.co.uk)